

Data sheet | Item number: 2020-105

1-conductor female plug; 1.5 mm<sup>2</sup>; 5-pole

2020-105

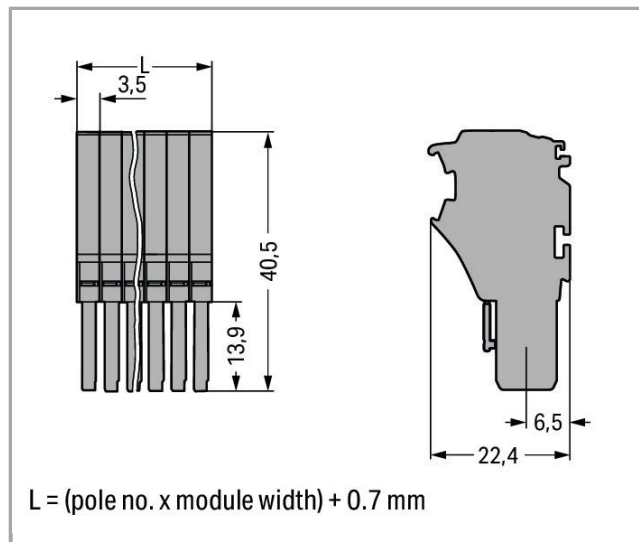
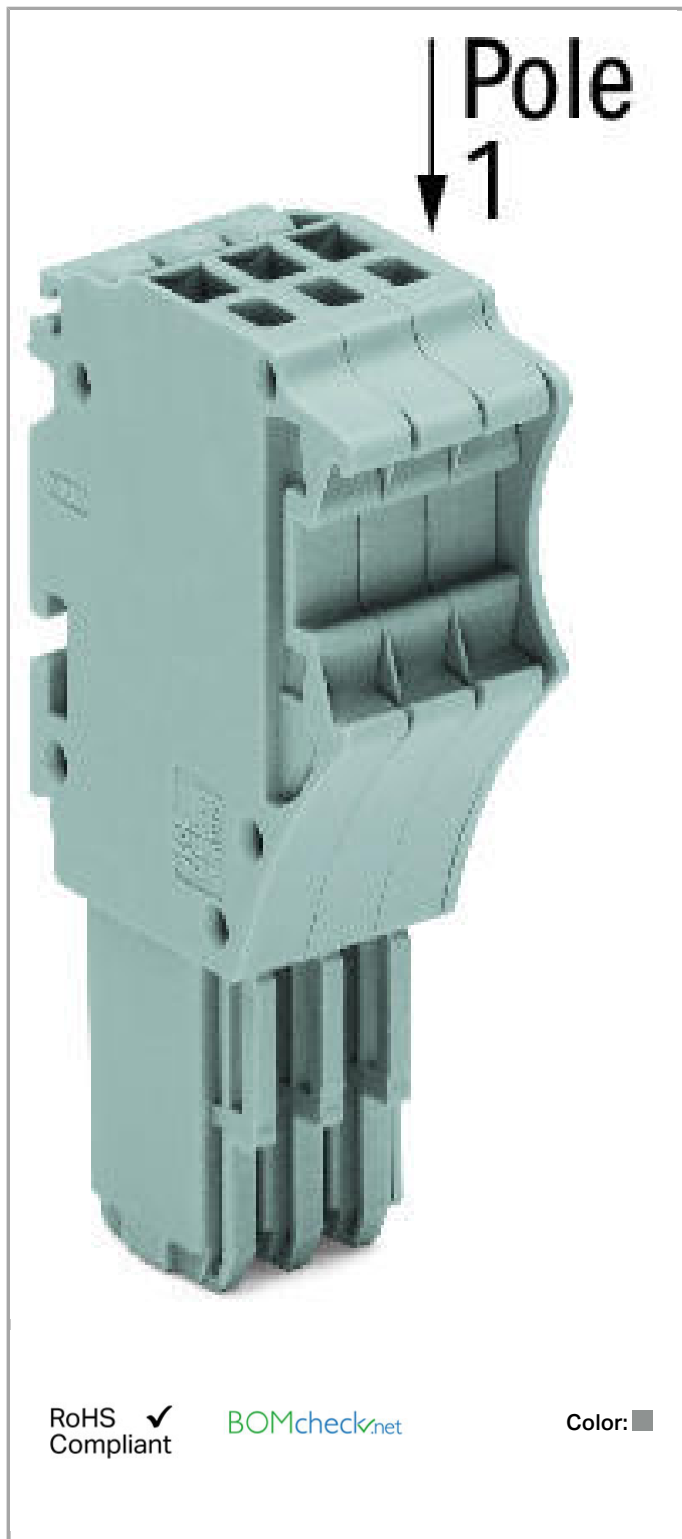

## Item description

According to EN 61984, pluggable connectors without current interrupting capacity shall not be mated and unmated when live or under load.

## Data

### Electrical data

#### Ratings per IEC/EN 60664-1

Rated voltage (III / 3)	500 V
Rated impulse voltage (III / 3)	6 kV
Rated current	13.5 A

#### Approvals per UL 1059

Rated voltage UL (Use Group B)	300 V
Rated current UL (Use Group B)	15 A
Rated voltage UL (Use Group C)	300 V
Rated current UL (Use Group C)	15 A
Rated voltage UL (Use Group D)	300 V
Rated current UL (Use Group D)	15 A

#### Approvals per CSA

Rated voltage CSA (Use Group B)	300 V
Rated current CSA (Use Group B)	10 A
Rated voltage CSA (Use Group C)	300 V
Rated current CSA (Use Group C)	10 A

## Connection data

Connection technology	Push-in CAGE CLAMP®
Actuation type	Open Tool Slot Push-in
Connectable conductor materials	Copper
Nominal cross section	1 mm <sup>2</sup>
Solid conductor	0.14 ... 1.5 mm <sup>2</sup> / 24 ... 16 AWG
Solid conductor, push-in termination	0.5 ... 1.5 mm <sup>2</sup> / 20 ... 16 AWG
Fine-stranded conductor	0.14 ... 1.5 mm <sup>2</sup> / 24 ... 16 AWG
Strip length	9 ... 11 mm / 0.35 ... 0.43 inch
Note (conductor cross-section)	Depending on the conductor characteristic, a conductor with a smaller cross section can also be inserted via push-in termination.
No. of poles	5

Total number of connection points	5
Total number of potentials	5
Type of wiring	Front-entry wiring

### Geometrical Data

Width	18.2 mm / 0.717 inch
Height	40.5 mm / 1.594 inch
Depth	22.4 mm / 0.882 inch
Module width	3.5 mm / 0.138 inch

### Mechanical data

Marking level	Side marking
---------------	--------------

### Plug connection

Contact type (pluggable connector)	Female connector/socket
Connector connection type	for conductors

### Material Data



Color	gray
Insulating material	Polyamide 66 (PA 66)
Fire load	0.208 MJ
Weight	11.57 g

### Commercial data

Country of origin	CN
GTIN	4050821245063
Customs Tariff No.	85366990990

### Approvals / Certificates





#### Country specific Approvals

Logo	Approval	Additional Approval Text	Certificate name
	CCA DEKRA Certification B.V.	EN 60947	NTR NL 7617
	CSA DEKRA Certification B.V.	C22.2 No. 158	2516073
	CSA	C22.2 No. 158	2516073





DEKRA Certification B.V.

## Ship Approvals

Logo	Approval	Additional Approval Text	Certificate name
	<b>ABS</b> American Bureau of Shipping	EN 60947	14- HG1293677- PDA
	<b>BV</b> Bureau Veritas S.A.	EN 60947	38586/A0 BV
	<b>DNV GL</b> Det Norske Veritas, Germanischer Lloyd	-	TAE00001V2
	<b>LR</b> Lloyds Register	EN 60947	91/20112 (E9)

## UL-Approvals

Logo	Approval	Additional Approval Text	Certificate name
	<b>UL</b> UL International Germany GmbH	UL 1059	E45172
	<b>UL</b> Underwriters Laboratories Inc.	UL 1059	E45172

## Compatible products



## Protective Warning Marker















Item no.: 2000-115  
Protective warning marker; with high-voltage symbol, black; for 5 terminal blocks

2000-115

## ferrule

	<b>Item no.: 216-241</b> Ferrule; Sleeve for 0.5 mm <sup>2</sup> / 20 AWG; insulated; electro-tin plated; electrolytic copper; gastight crimped; acc. to DIN 46228, Part 4/09.90	216-241
	<b>Item no.: 216-242</b> Ferrule; Sleeve for 0.75 mm <sup>2</sup> / 18 AWG; insulated; electro-tin plated; electrolytic copper; gastight crimped; acc. to DIN 46228, Part 4/09.90	216-242
	<b>Item no.: 216-243</b> Ferrule; Sleeve for 1 mm <sup>2</sup> / AWG 18; insulated; electro-tin plated; electrolytic copper; gastight crimped; acc. to DIN 46228, Part 4/09.90	216-243

## Marking accessories

	<b>Item no.: 2009-110</b> Marking strips; on reel; not stretchable; plain; snap-on type	2009-110
	<b>Item no.: 2009-113</b> WMB-Inline; for Smart Printer; on reel; plain; snap-on type	2009-113
	<b>Item no.: 2009-113/000-002</b> WMB-Inline; for Smart Printer; on reel; plain; snap-on type	2009-113 /000-002
	<b>Item no.: 2009-113/000-005</b> WMB-Inline; for Smart Printer; on reel; plain; snap-on type	2009-113 /000-005
	<b>Item no.: 2009-113/000-006</b> WMB-Inline; for Smart Printer; on reel; plain; snap-on type	2009-113 /000-006
	<b>Item no.: 2009-113/000-007</b> WMB-Inline; for Smart Printer; on reel; plain; snap-on type	2009-113 /000-007
	<b>Item no.: 2009-113/000-012</b> WMB-Inline; for Smart Printer; on reel; plain; snap-on type	2009-113 /000-012
	<b>Item no.: 2009-113/000-017</b> WMB-Inline; for Smart Printer; on reel; plain; snap-on type	2009-113 /000-017
	<b>Item no.: 2009-113/000-023</b> WMB-Inline; for Smart Printer; on reel; plain; snap-on type	2009-113 /000-023
	<b>Item no.: 2009-113/000-024</b> WMB-Inline; for Smart Printer; on reel; plain; snap-on type	2009-113 /000-024
	<b>Item no.: 210-831</b> Marking strips; on reel; 2.3 mm wide; plain; Self-adhesive	210-831
	<b>Item no.: 210-832</b> Marking strips; on reel; 3 mm wide; plain; Self-adhesive	210-832
	<b>Item no.: 210-833</b> Marking strips; on reel; 6 mm wide; plain; Self-adhesive	210-833

	<b>Item no.: 210-834</b> Marking strips; on reel; 5 mm wide; plain; Self-adhesive	210-834
	<b>Item no.: 793-3501</b> WMB marking card; as card; plain; snap-on type	793-3501
<b>Strain relief plate</b>		
	<b>Item no.: 734-328</b> Strain relief plate	734-328
<b>tools</b>		
	<b>Item no.: 210-647</b> Operating tool with partially insulated shaft; Blade (2.5 x 0.4) mm; short	210-647
	<b>Item no.: 210-648</b> Operating tool with partially insulated shaft; Blade (2.5 x 0.4) mm; short; angled	210-648
	<b>Item no.: 210-719</b> Operating tool with partially insulated shaft; Type 1, blade (2.5 x 0.4) mm	210-719
<b>Locking lever</b>		
	<b>Item no.: 2022-141</b> Locking lever; can be snapped on 1-conductor female plugs; for 1-pole female plugs	2022-141
	<b>Item no.: 2022-142</b> Locking lever; can be snapped on 1-conductor female plugs; for 1-pole female plugs	2022-142
	<b>Item no.: 2022-151</b> Locking lever; can be snapped on 1-conductor female plugs; 2 poles and more	2022-151
	<b>Item no.: 2022-152</b> Locking lever; can be snapped on 1-conductor female plugs; 2 poles and more	2022-152

**Downloads****Documentation****Bid Text**

2020-105	docx 15.3 kB	Download
----------	-----------------	----------

**Additional Information**

	pdf 2.1 MB	Download
--	---------------	----------

**CAD/CAE - Smart Data****CAD data**

3D Download 2020-105	URL	Download
----------------------	-----	----------



Product family

X-COM S-Mini

Show all products from the family

Subject to changes.

---